

PERFORMANCE CURVES

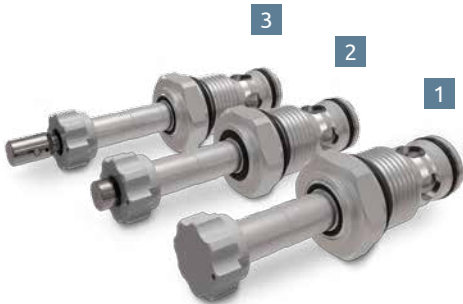
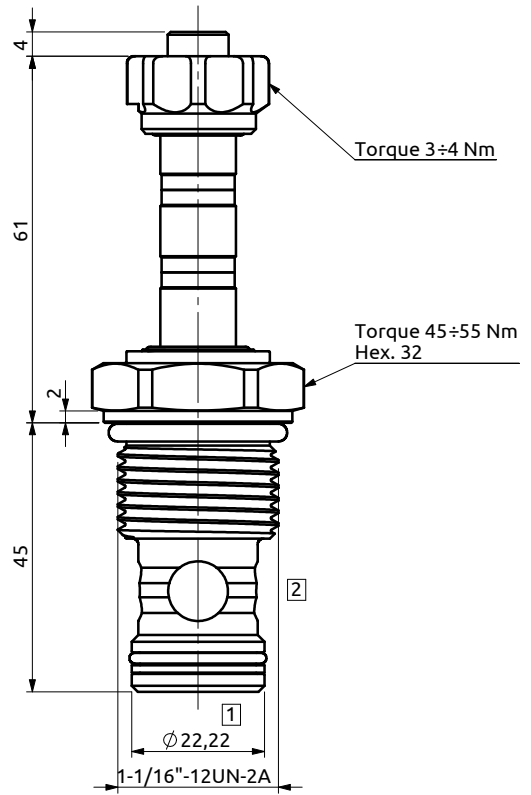
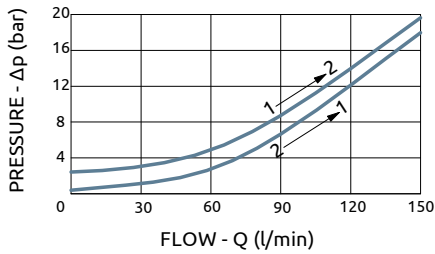

	MANUAL OVERRIDE	ORDERING CODE
1	Not adjustable	E223120000
2	Push button	E223122000
3	Push&twist button	E223123000

PRESSURE	350 bar
FLOW	150 l/min
CAVITY	SAE 12
SEALS	NBR

INTERNAL LEAKAGE	0.15 cc/min
OIL TEMPERATURE	-40 ÷ 120 °C
FILTRATION	25 µm or better
WEIGHT	0.23 kg

Continuous duty coil must be ordered separately, see section 02