

PERFORMANCE CURVES

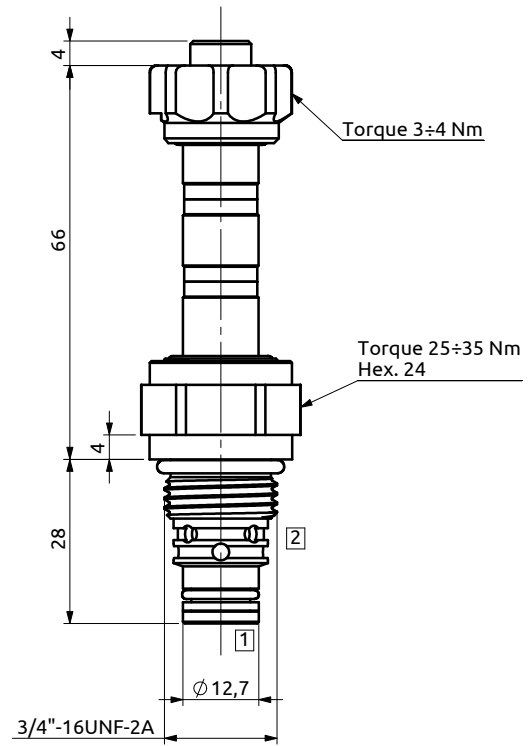
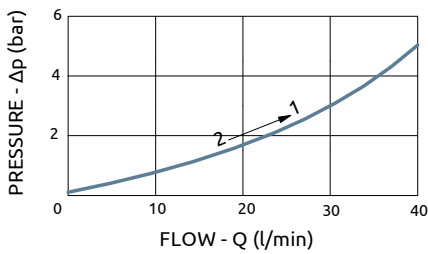

	MANUAL OVERRIDE	ORDERING CODE
1	Not adjustable	E122080000
2	Manual screw	E122081000

PRESSURE	350 bar
FLOW	40 l/min
CAVITY	SAE 08
SEALS	NBR

INTERNAL LEAKAGE	0.15 cc/min
OIL TEMPERATURE	-40 ÷ 120 °C
FILTRATION	25 µm or better
WEIGHT	0.13 kg

Continuous duty coil must be ordered separately, see section 02